

SOLID

Art. 2914 - 44 x 20 P43,5 Cm

- x1 Contenitore metallico profondità 43,5 cm per art. 2902
- x1 Metal container 43.5 cm depth for art. 2902
- x1 Caisson métallique profondeur 43,5 cm pour art. 2902
- x1 Metallbehälter, Tiefe 43,5 cm für Artikel 2902
- x1 Contenedor metálico profundidad 43,5 cm para art. 2902
- x1 Металлический контейнер глубиной 43,5 см для арт. 2902

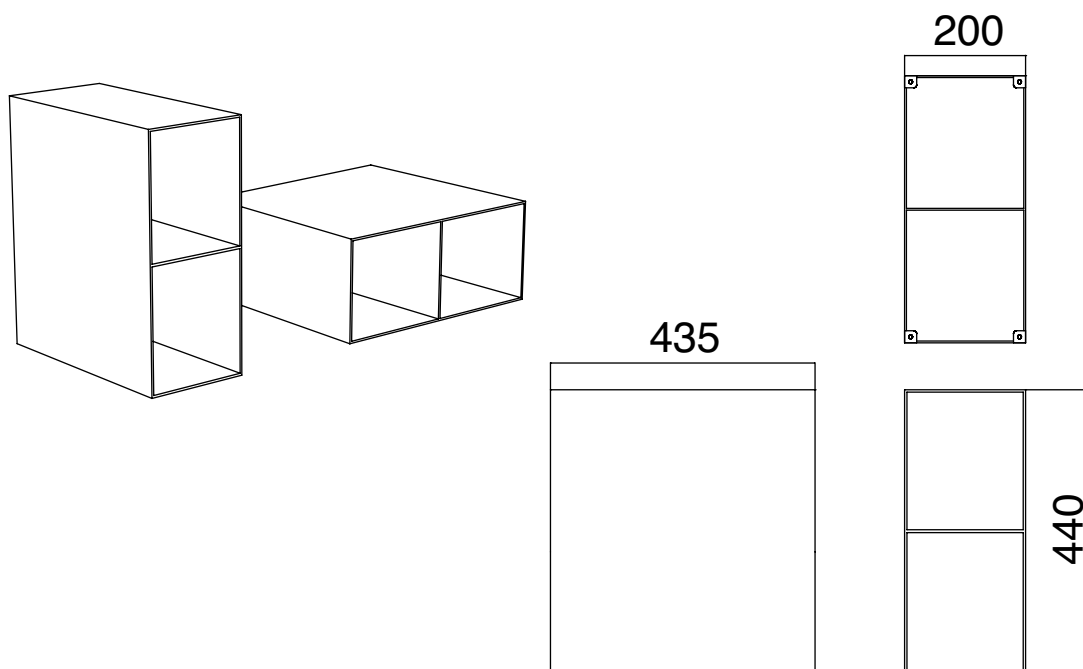

Tolleranza dimensioni $\pm 5\%$

Dimension tolerance $\pm 5\%$